

SERIE NOVA / NOVA MEDIA

CARATTERISTICHE TECNICHE:	
SEZIONE ANTA:	57x78 MM.
SEZIONE TELAIO:	57x80 MM.
SPESS. VETRO:	20-23 MM.
TRASMITTANZA TERMICA NODI	
NODO LATERALE	1,52 UW
NODO CENTRALE	1,44 UW
NODO INFERIORE FIN.	1,65 UW
NODO INFERIORE P. FIN.	1,83 UW
TRASMITTANZA TERMICA UW	(MISURA 1300X1500)
4 / 12 / 4 BE	1,91 UW
4 / 12 ARGON / 4 BE	1,80 UW
4/ 12 ARGON SW/4 BE	1,63 UW
(SW = SWISSPACER)	
ABBATIMENTO ACUSTICO	
VETRO 3+3 / 12 / 3+3 SS	39 DB
FERRAMENTA DI SERIE	ANUBA DIAM.14
FERRAMENTA OPTIONAL	ANUBA DOPPIO GAMBO
GOCCIOLATOIO ALLUM.	DI SERIE
GOCCIOLATOIO IN LEGNO	OPTIONAL
GARANZIA VERN. 5 ANNI	DI SERIE
GARANZIA VERN. 10 ANNI	OPTIONAL

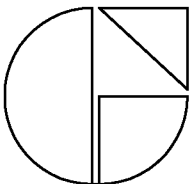

GASPARRINI M.B.M. SRL
 VIA MARGONI, 19
 62010 APPIGNANO
 (MC) ITALY

CARATTERISTICHE
 TECNICHE NOVA

SERIE NOVA / NOVA MEDIA

PROVE DI LABORATORIO

FINESTRA

RESISTENZA AL VENTO

TENUTA ALL'ACQUA

PERMEABILITA' ALL'ARIA

UNI EN 12210 - C3

UNI EN 12208 5A

UNI EN 12207 4

PORTA FINESTRA

RESISTENZA AL VENTO

TENUTA ALL'ACQUA

PERMEABILITA' ALL'ARIA

UNI EN 12210 - C3

UNI EN 12208 6A

UNI EN 12207 4

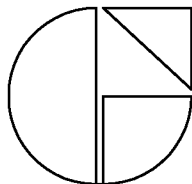

GASPARRINI M.B.M. SRL
VIA MARGONI, 19
62010 APPIGNANO
(MC) ITALY

CARATTERISTICHE
TECNICHE NOVA

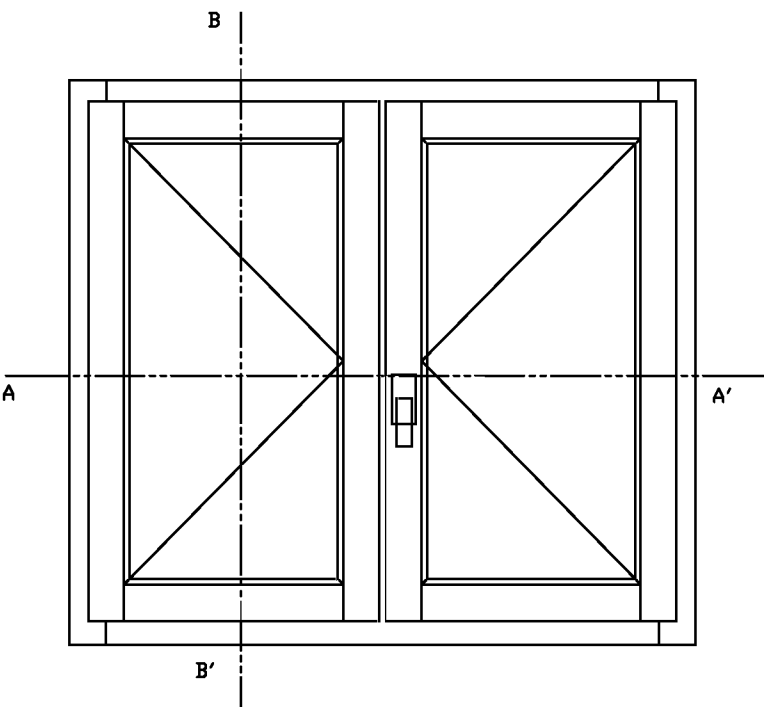

CARATTERISTICHE TECNICHE:
SEZIONE ANTA: 57x78 MM.
SEZIONE TELAIO: 57x80 MM.
SPESSORE VETRO: 20 MM.

Sezione B-B'

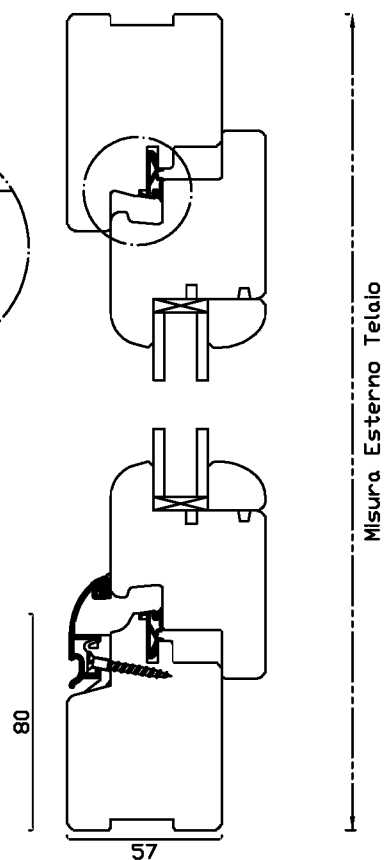
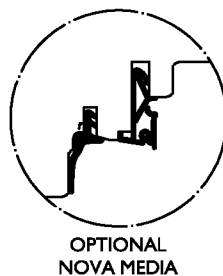

IMPORTANTE: LA DITTA SI RISERVA LA FACOLTA' DI APPORTARE MODIFICHE SENZA DARNE PREAVVISO.

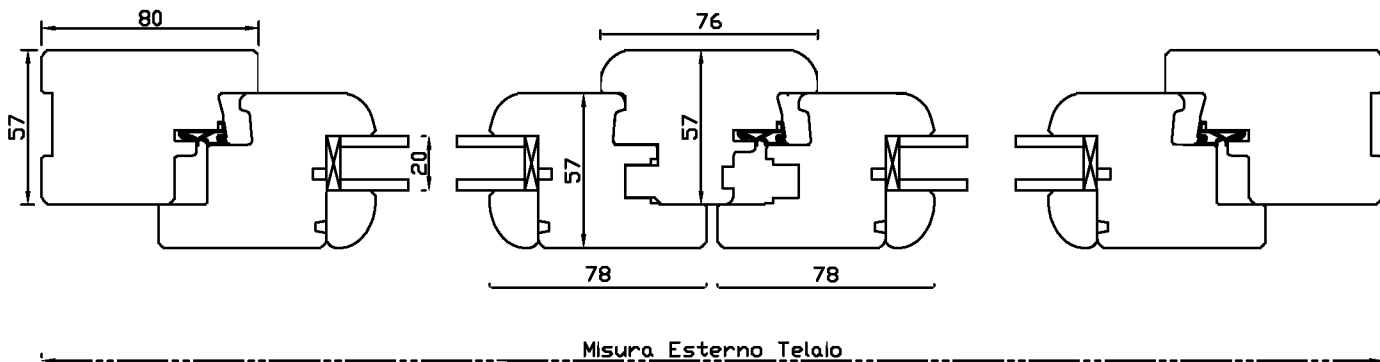

Sezione A-A'

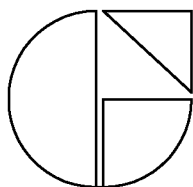

GASPARRINI M.B.M. SRL
VIA MARGONI, 19
62010 APPIGNANO
(MC) ITALY

SERRAMENTO TIPO:
NOVA LEGNO

Tav. BI

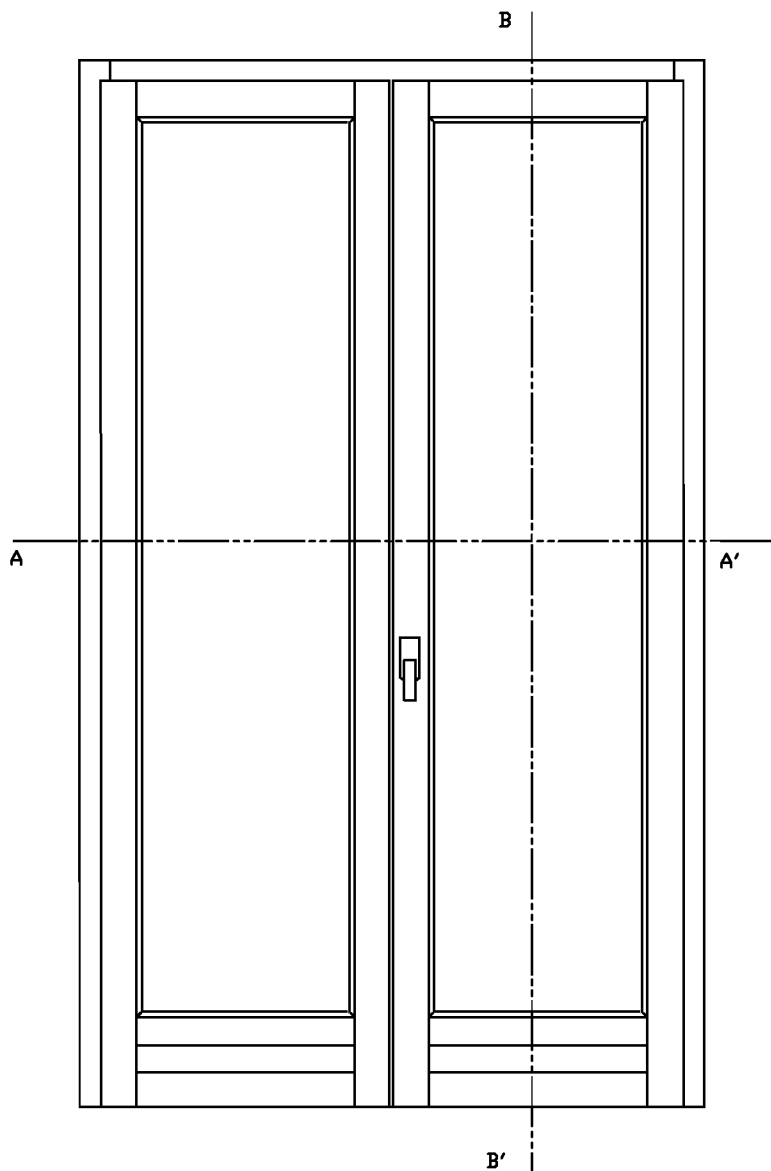

CARATTERISTICHE TECNICHE:
SEZIONE ANTA: 57x78 MM.
SEZIONE TELAIO: 57x80 MM.
SPESSORE VETRO: 20 MM.

Sezione B-B'

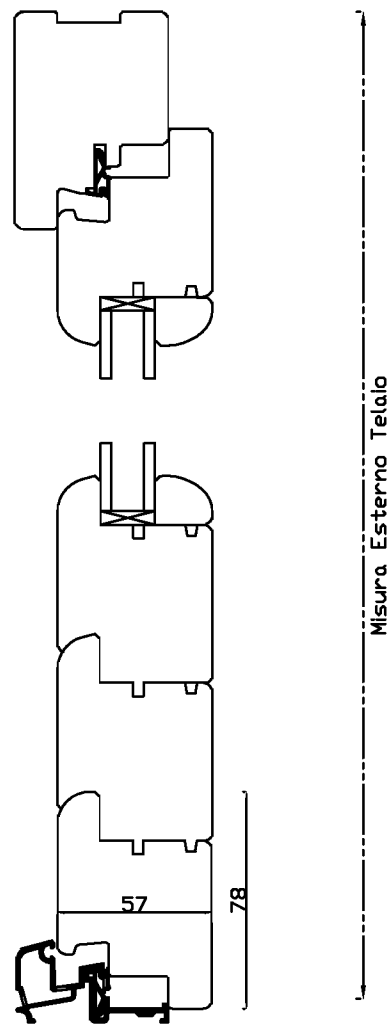

IMPORTANTE: LA DITTA SI RISERVA LA FACOLTA' DI APPORTARE MODIFICHE SENZA DARNE PREAVVISO.

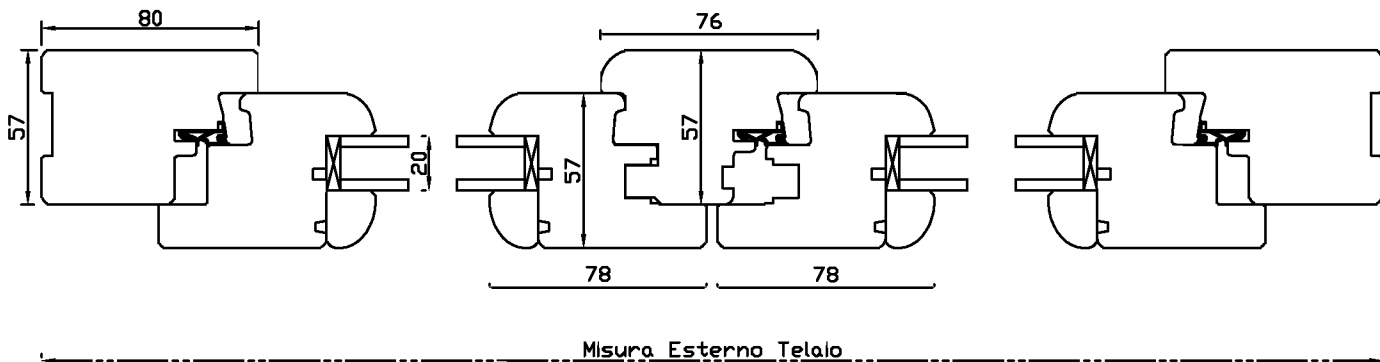

Sezione A-A'

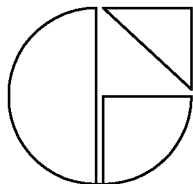

GASPARRINI M.B.M. SRL
 VIA MARGONI, 19
 62010 APPIGNANO
 (MC) ITALY

SERRAMENTO TIPO:
 NOVA LEGNO
 PORTA FINESTRA SENZA
 TRAVERSO

Tav. B2

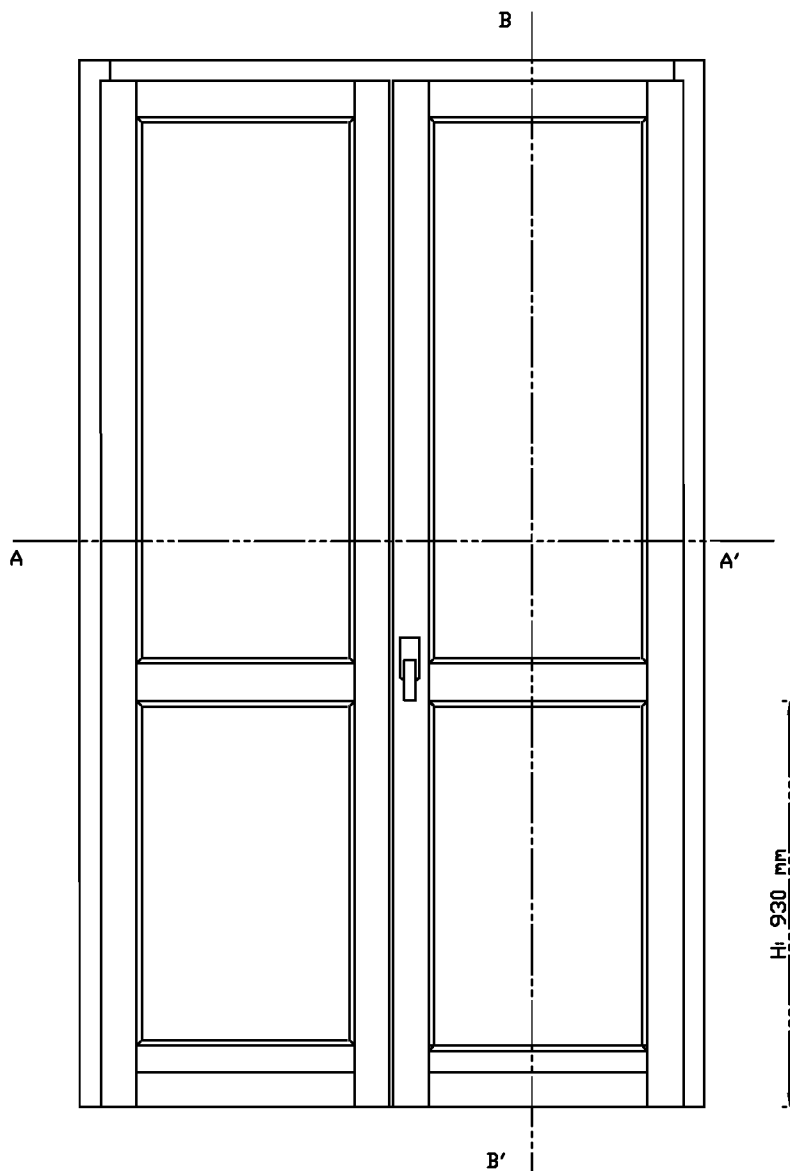

CARATTERISTICHE TECNICHE:
SEZIONE ANTA: 57x78 MM.
SEZIONE TELAIO: 57x80 MM.
SPESSORE VETRO: 20 MM.

Sezione B-B'

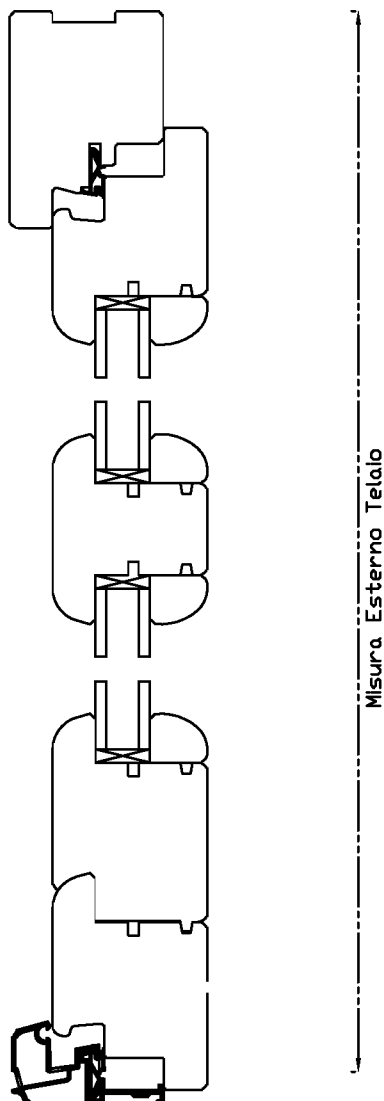

Misura Esterno Telaio

IMPORTANTE: LA DITTA SI RISERVA LA FACOLTA' DI APPORTARE MODIFICHE SENZA DARNE PREAVVISO.

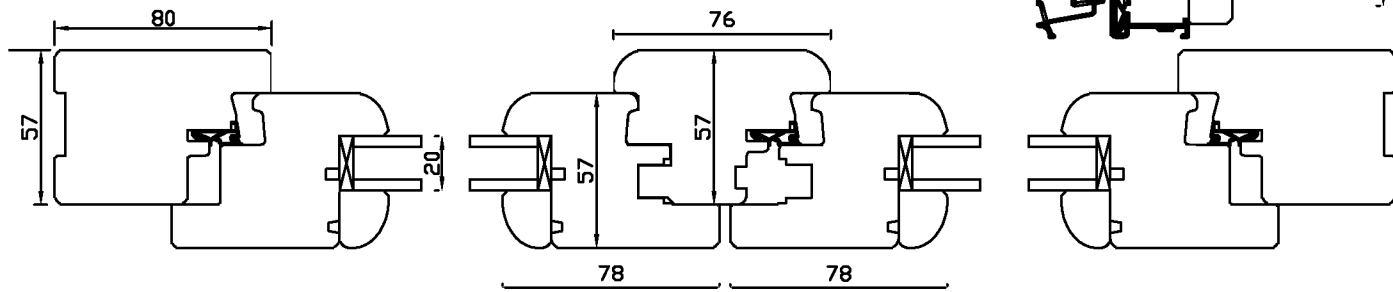

Misura Esterno Telaio

Sezione A-A'

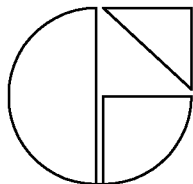

GASPARRINI M.B.M. SRL
VIA MARGONI, 19
62010 APPIGNANO
(MC) ITALY

SERRAMENTO TIPO:
NOVA LEGNO
PORTA FINESTRA CON
TRAVERSO

Tav. B3

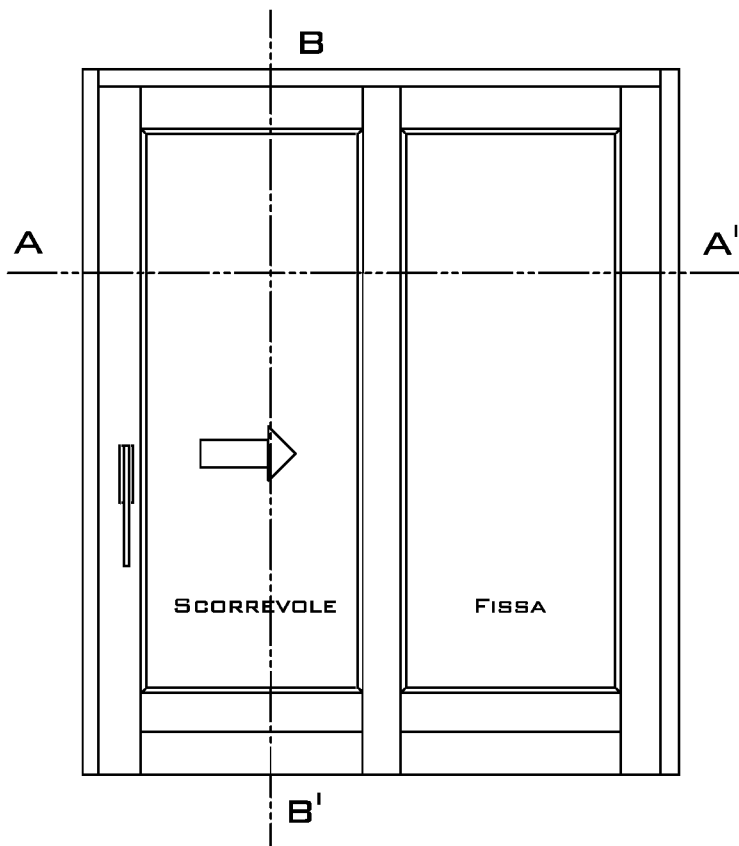

CARATTERISTICHE TECNICHE:
SEZIONE ANTA: 57X110 MM.
SEZIONE TEL.: 50X158 MM.
SPESSORE VETRO: 20 MM.

SEZIONE B-B'

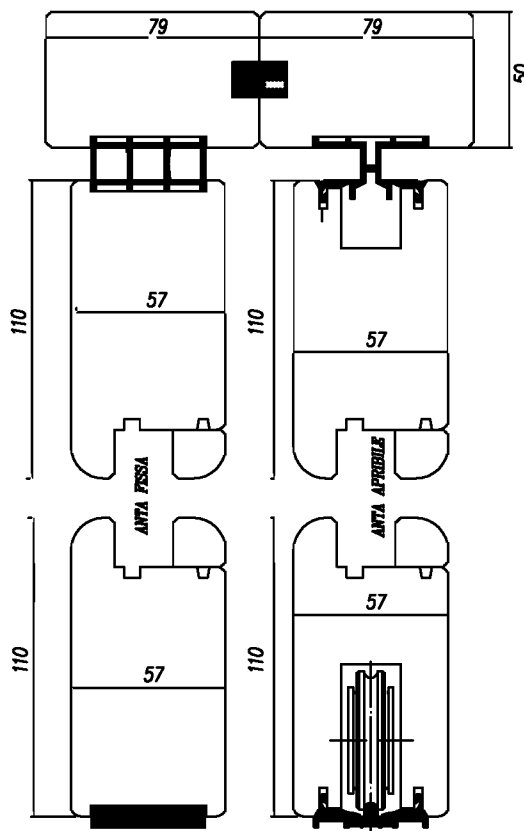

Misura Esterno Telaio

IMPORTANTE: LA DITTA SI RISERVA LA FACOLTA' DI APPORTARE MODIFICHE SENZA DARNE PREAVVISO.

SEZIONE A-A'

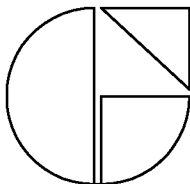
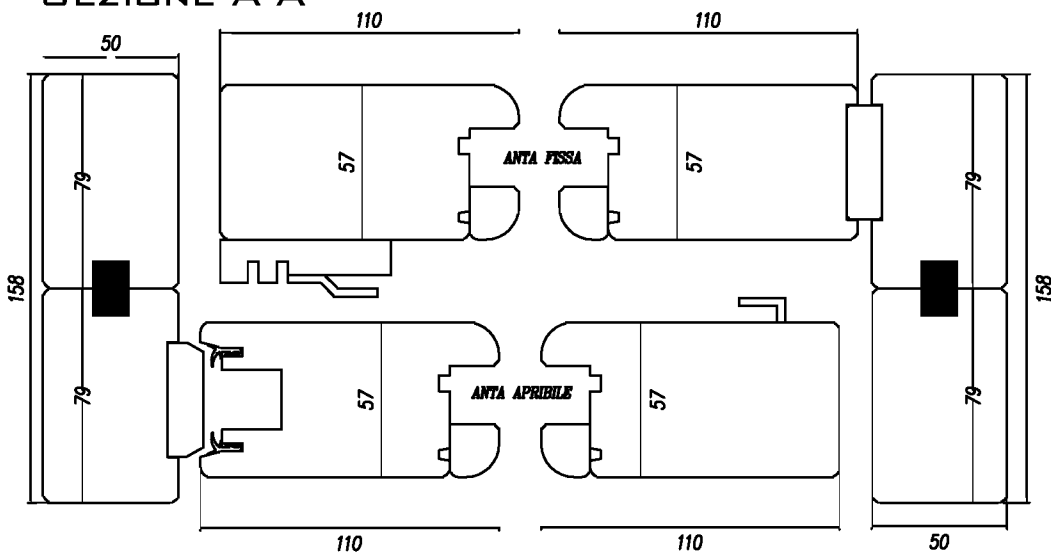

GASPARRINI M.B.M. SRL
 VIA MARGONI, 19
 62010 APPIGNANO
 (MC) ITALY

**SERIE NOVA
 ALZANTE
 SCORREVOLE**

Tav. B4

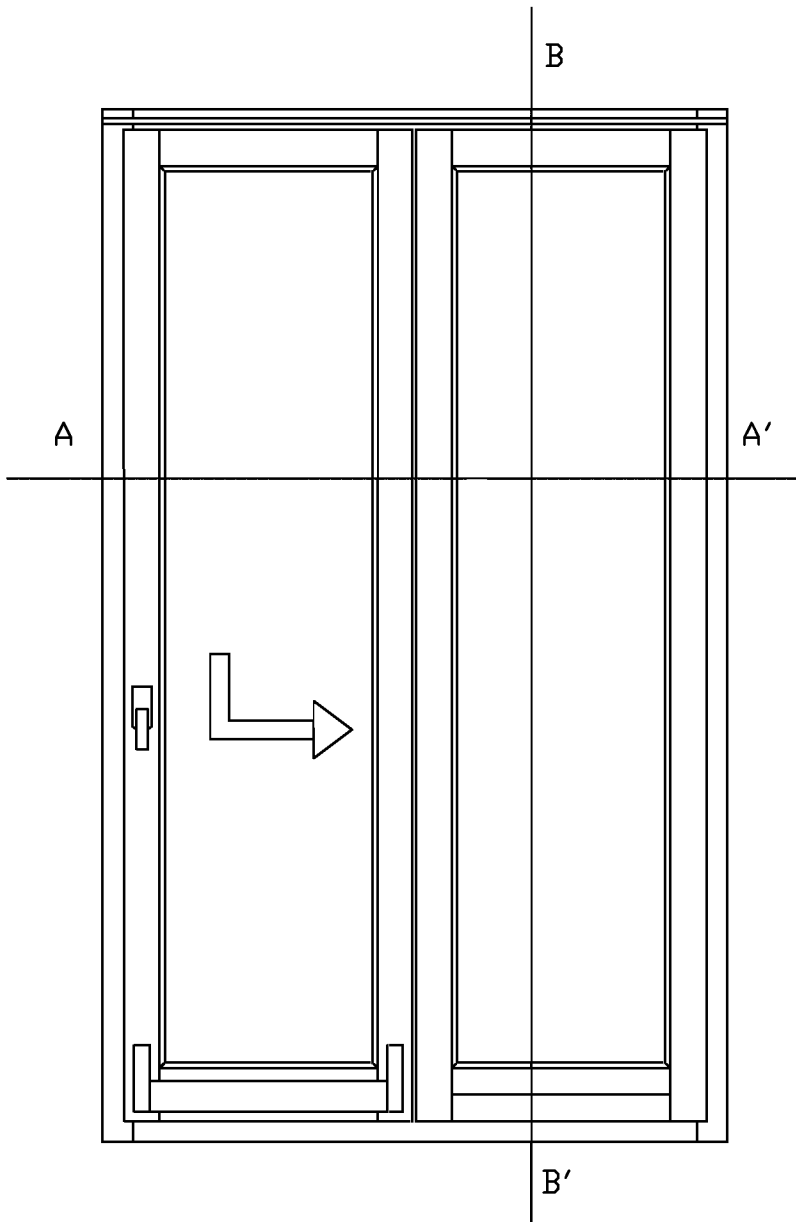

CARATTERISTICHE TECNICHE:
SEZIONE ANTA: 57x78 MM.
SEZIONE TELAIO: 57x80 MM.
SPESSORE VETRO: 20 MM.

Sezione B-B'

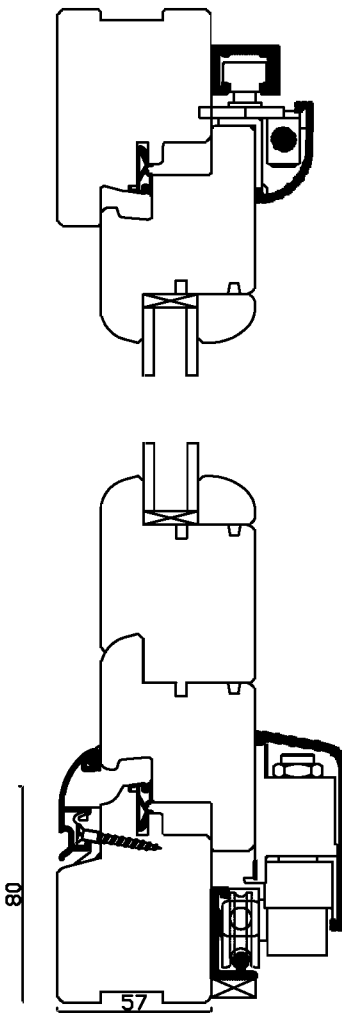

IMPORTANTE: LA DITTA SI RISERVA LA FACOLTA' DI APPORTARE MODIFICHE SENZA DARNE PREAVVISO.

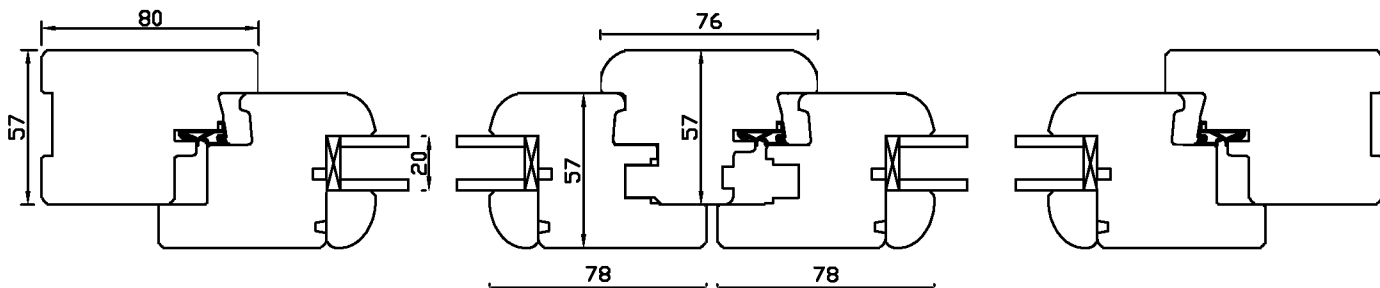

Misura Esterno Telaio

Sezione A-A'

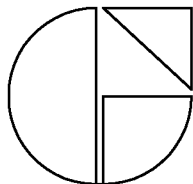

GASPARRINI M.B.M. SRL
VIA MARGONI, 19
62010 APPIGNANO
(MC) ITALY

SERRAMENTO TIPO:
NOVA LEGNO
SCORREVOLE PARALLELO

Tav. B5

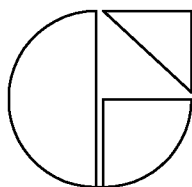
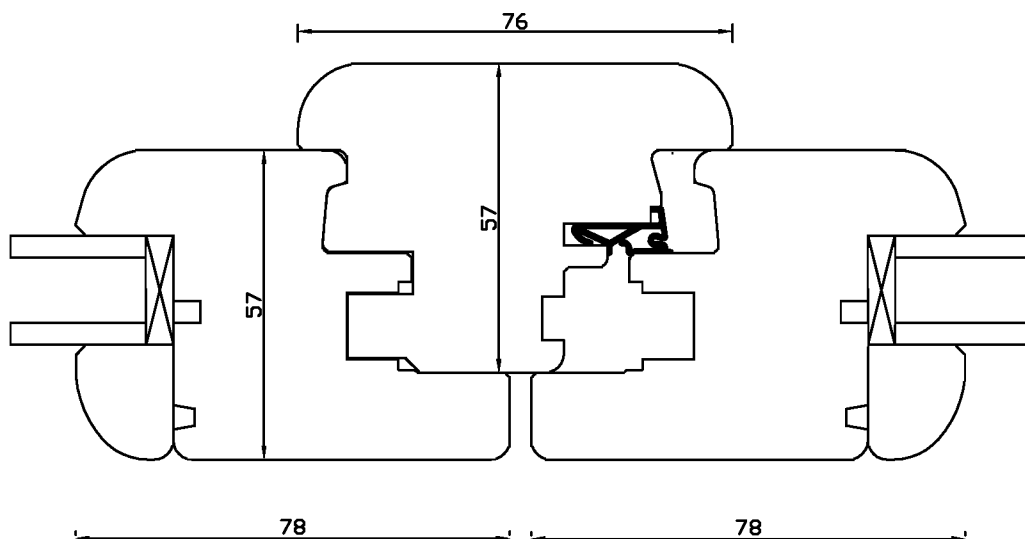
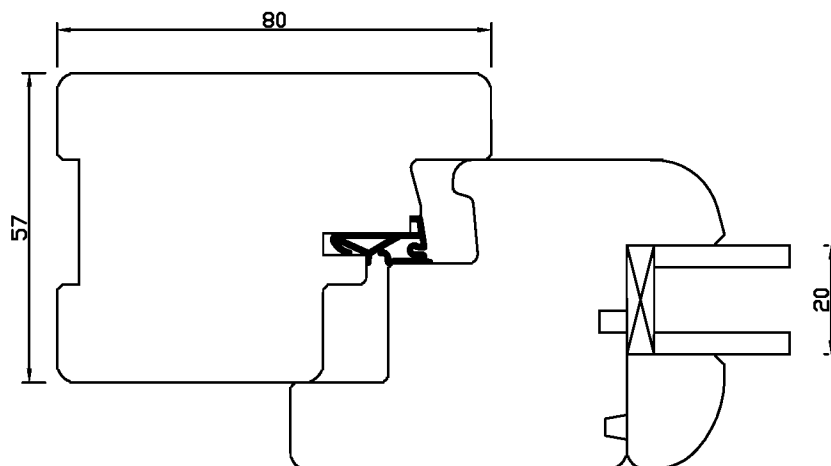

GASPARRINI M.B.M. SRL
VIA MARGONI, 19
62010 APPIGNANO
(MC) ITALY

NODI
SERIE NOVA

Tav. B6

Soluzione 1

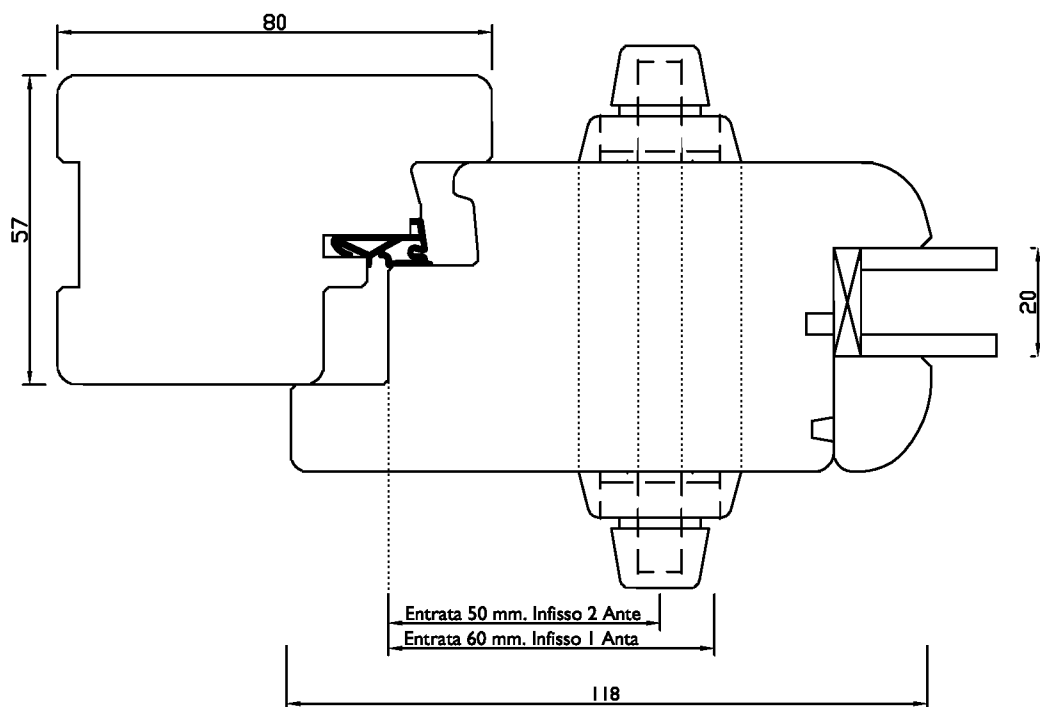

Soluzione 2 Standard

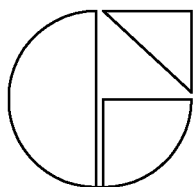
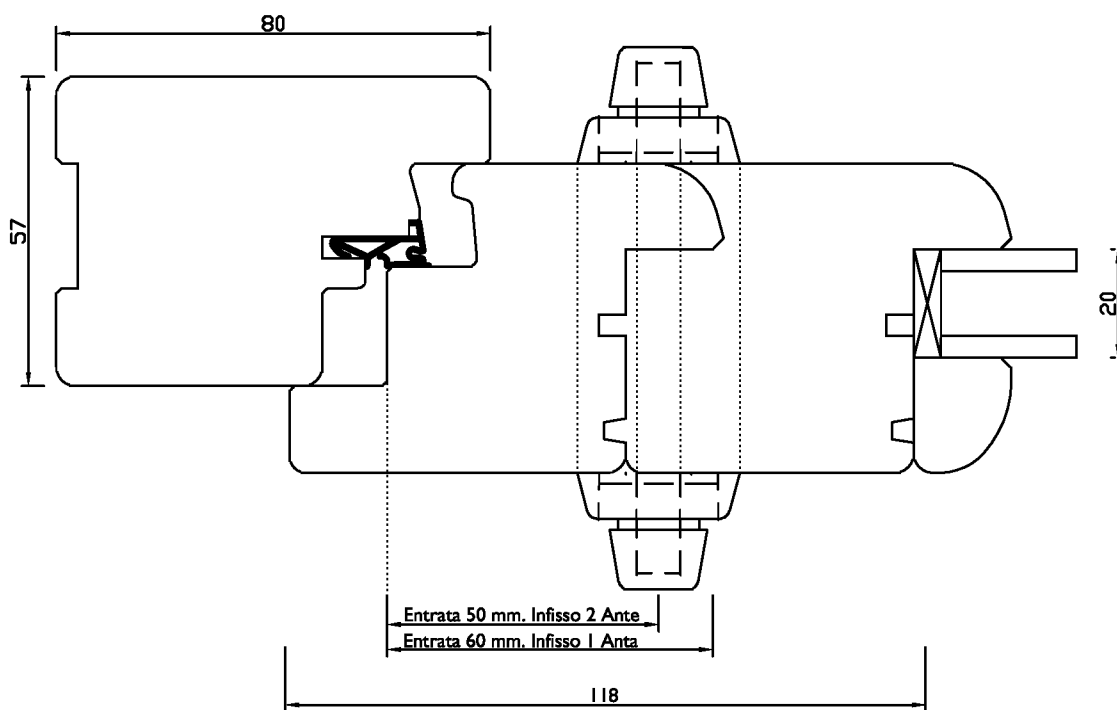

GASPARRINI M.B.M. SRL
VIA MARGONI, 19
62010 APPIGNANO
(MC) ITALY

NODI
SERIE NOVA
MONTANTI YALE

Tav. B7

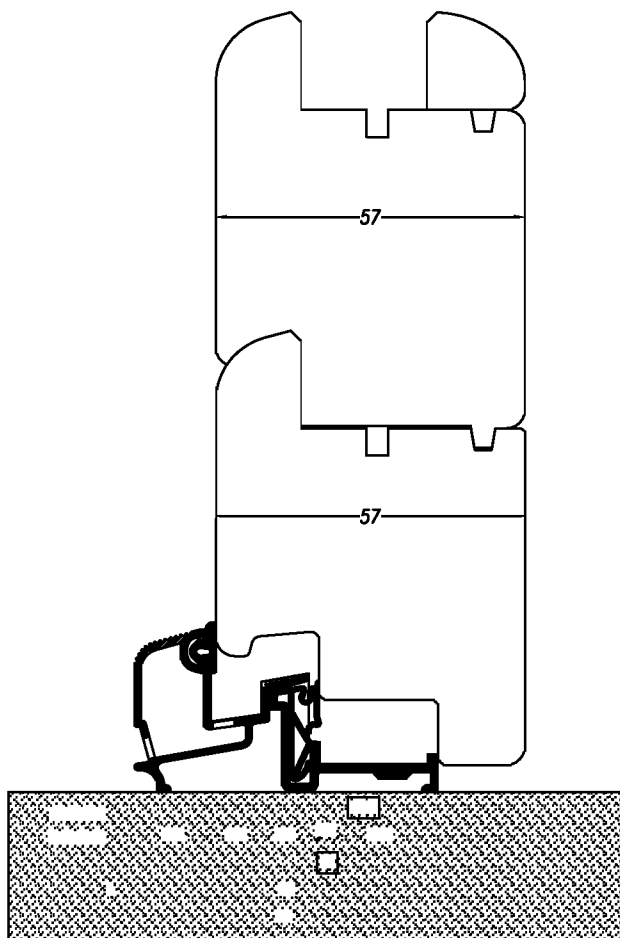

Soluzione Standard

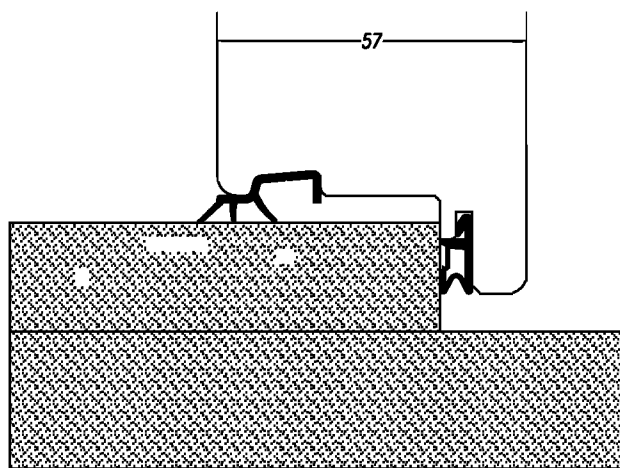

Soluzione con Battuta Marmo (Non Certificata)

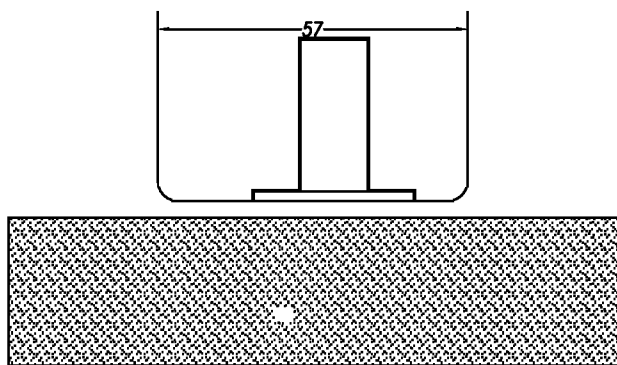

Soluzione con Soglia Parafreddo (Non Certificata)

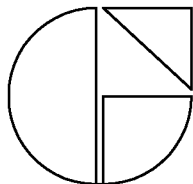

GASPARRINI M.B.M. SRL
VIA MARGONI, 19
62010 APPIGNANO
(MC) ITALY

NODI INFERIORI
SERIE NOVA

Tav. B8